

THE INFORMATION CONTAINED IN THIS DOCUMENT IS PROPRIETARY TO Y-S ELECTRONIC, ANY REPRODUCTION IN PART OR WHOLE WITHOUT PRIOR WRITTEN APPROVAL OR AUTHORIZATION OF Y-S ELECTRONIC IS STRICTLY PROHIBITED.

RoHS COMPLIANT

REVISIONS				
REV	ECN NO.	DESCRIPTION	APPROVED BY	DATE
G	⚠	A0603471	KING CHIU	2006-03-28

CRIMP High feet male terminal

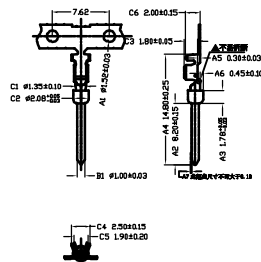

CRIMP Low feet male terminal

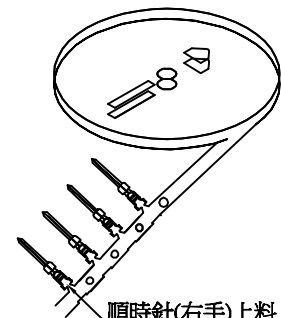
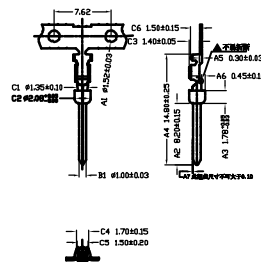

順時針(右手)上料

杯口朝內

clockwise (right hand feed)winding

CRIMP High feet female terminal

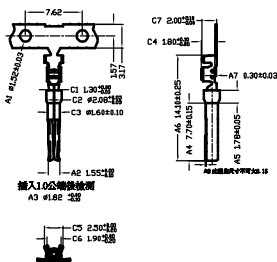

CRIMP Low feet female terminal

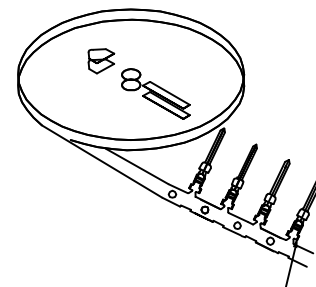
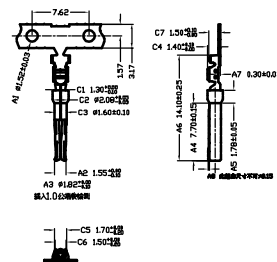

逆時針(左手)上料

杯口朝內

counterclockwise(left hand feed) winding

102 TERMINAL SERIES CRIMP TYPE
Ordering Information

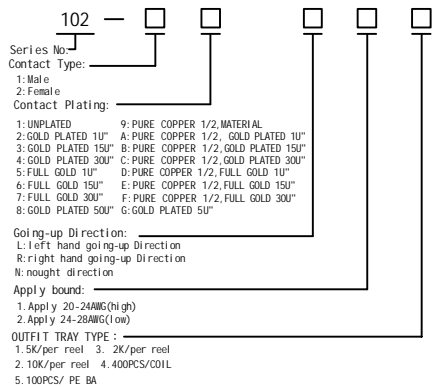

- NOTE:
- 1.Crimp, counterclockwise(left hand feed) winding, clockwise. (right hand feed)winding.
 2. Use the white foam rubber 030 stick(hengfeng brand) to gather the acetic acid ethylene lotion styrafoam and cardboard.
 - 3.No transparent tape is allowed to upper and lower cardboard.

10	CARDBOARD:φ11.5*0.7CM(inside cavern)(A3A)	2/400	PCS	
9	PE BAG:4"4"0.06MM	1/100	PCS	
8	CARTON-IN:22"30.5"20CM(A3A) 100PCS PACKING	XX/K	PCS	
7	CARTON:46.5"35"22.5CM (nothing any printing) 400PCS OR 100PCS PACKING	XX/K	PCS	
6	CARDBOARD:φ50*0.6CM(K-K)	2/10K	PCS	
5	CARTON:51"51"29CM(K4B4K) 10K PACKING	1/8	TRAY	
4	STYROFOAM: φ4.5*0.7(inside cavern)*2.3CM	1	PCS	
3	CARDBOARD:φ37*0.6CM(K-K)	2/5K	PCS	
2	CARTON:38"38"36CM(K4B4K) 2K PACKING	1/10	TRAY	
1	TERMINAL:Crmp φ1.0mm XX	1/5K	TRAY	
NO	PART NO.	DESCRIPTION	QTY	UNIT

DIMENSIONS: <input type="checkbox"/> MM [INCH] <input type="checkbox"/> INCH [mm] <input checked="" type="checkbox"/> MM ONLY	CAD GENERATED DRAWING, DO NOT MANUALLY UPDATE	<p>Y-S ELECTRONIC CO., LTD. No. 101, Sec. 1, Long-An Street, Lu-Chu, Taoyuan, Taiwan, R.O.C. TEL: +886-3-3609819 FAX: +886-3-3609817</p>
UNLESS OTHERWISE SPECIFIED, GENERAL TOLERANCE: DECIMALS ANGLES X: ±0.38 [0.015] X°: ±3° .X: ±0.25 [0.010] .X°: ±1.0° .XX: ±0.13 [0.005]	CHECKED BY AND DATE JUSTIN XING 08-23-04	
MATERIAL	APPROVED BY AND DATE KING CHIU 08-23-04	TITLE 102 SERIES D-SUB CRIMP TERMINAL
FINISH	THIRD ANGLE PROJECTION 	DRAWING NO. 102-XXXXX
	SCALE: NONE SIZE: A3	REV G
		FILE NO. SHEET 1 OF 1

DO NOT SCALE DRAWING